

Arduino I²C RTD Sample Code

Revised 11/19

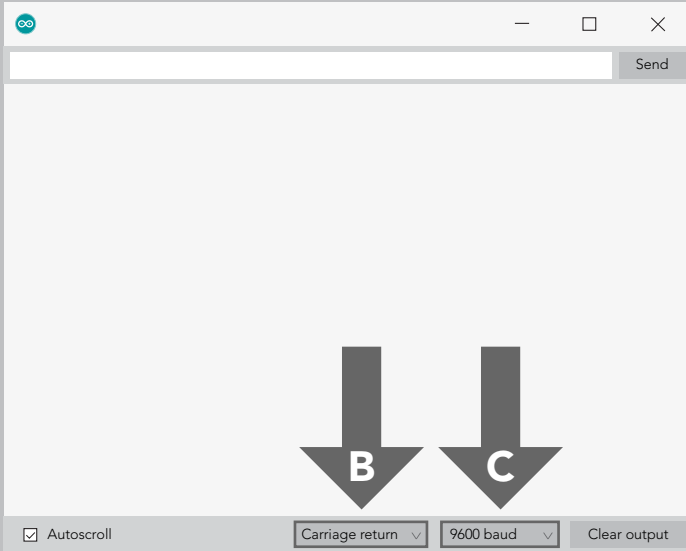
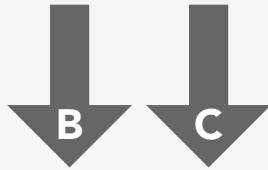

Setup

1. Set the EZO device into I²C mode.
2. Flash Arduino with sample code.
3. Open serial monitor. (A)
4. Set to carriage return. (B)
5. Set 9600 baud. (C)

Arduino Mega

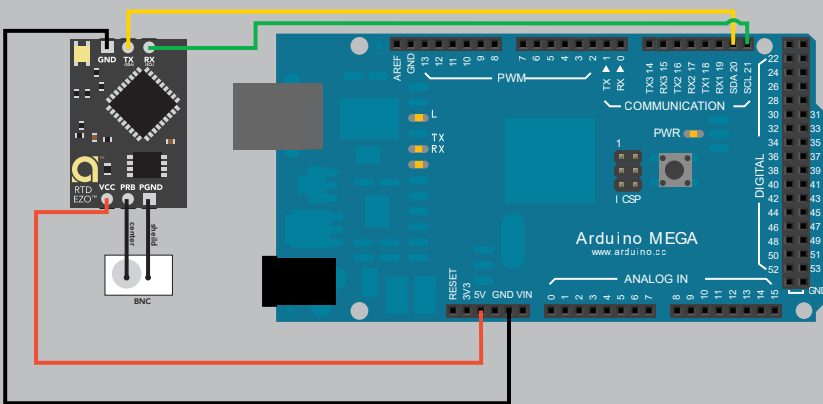

Arduino Uno

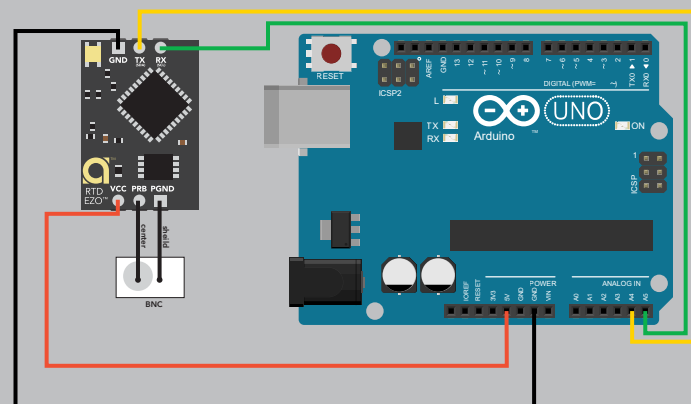

[Click here to download the sample code](#)