

Arduino Mega

RTD Sample Code

Revised 6/2019

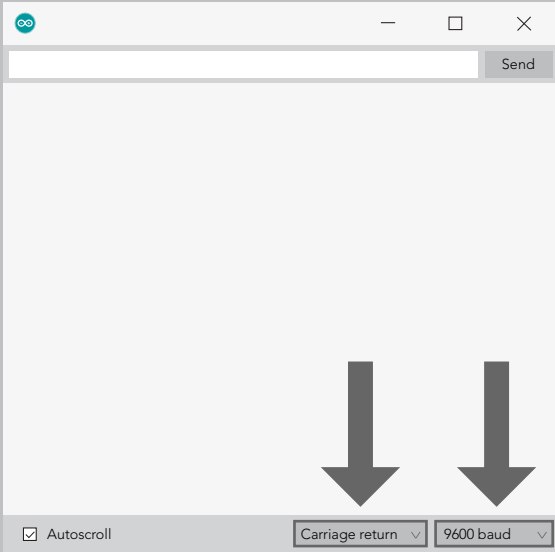

After flashing the Arduino with the code below, open the serial monitor and set it to append *carriage return* only and then set the baud rate to **9600**.

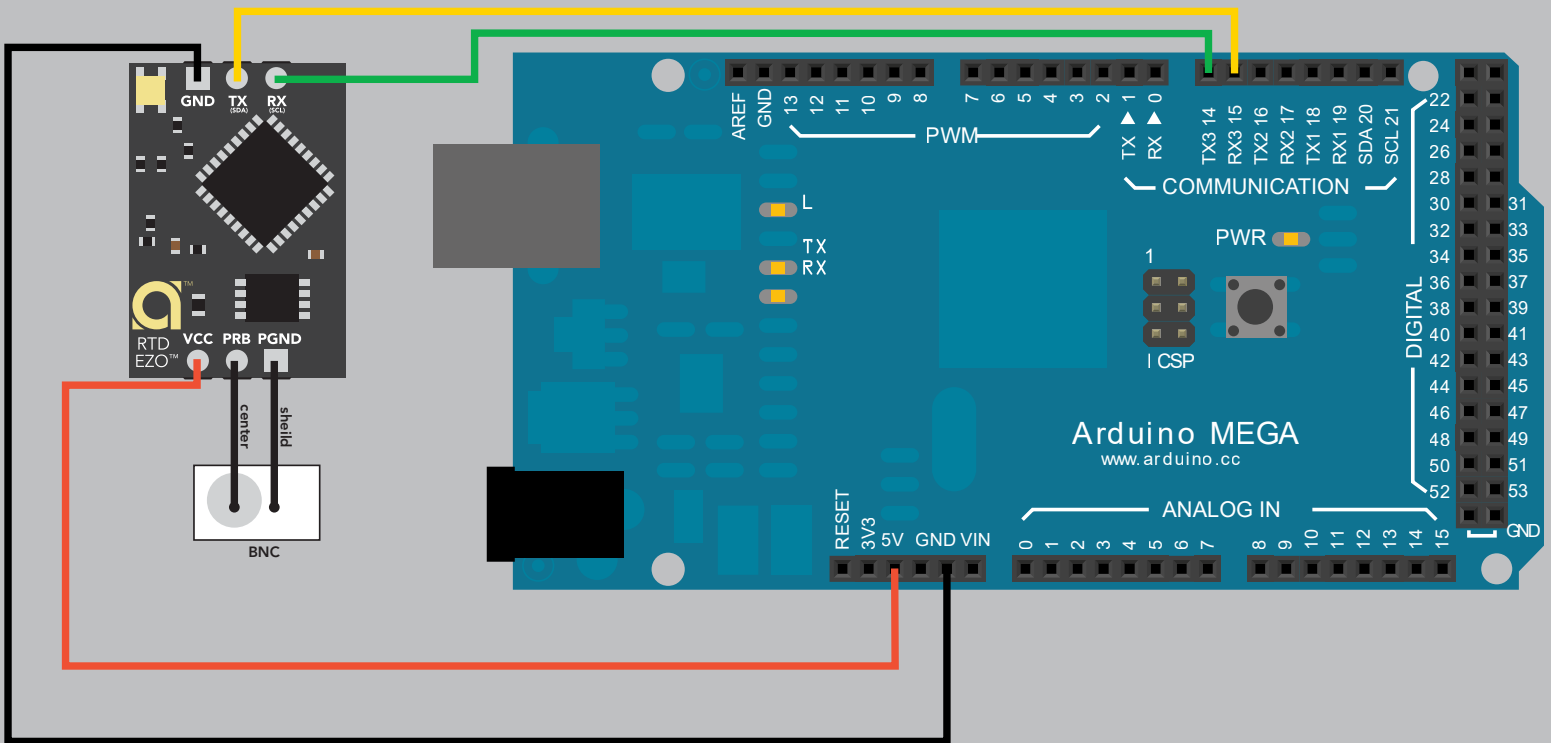

[Click here to download the sample code](#)