

Industrial pH Probe

Double junction silver / silver chloride

Reads	pH
Range	0 – 14
Accuracy	+/- 0.002
Connector	Tinned leads
Resolution	+/- 0.0001
Response time	95% in 1s
Max pressure	100 PSI
Max depth	60m (197 ft)
Temperature range °C	1 – 99 °C
Cable length	3 meters
Internal temperature sensor	Yes (PT-1000)
Time before recalibration	~1 Year
Life expectancy	~4 Years +

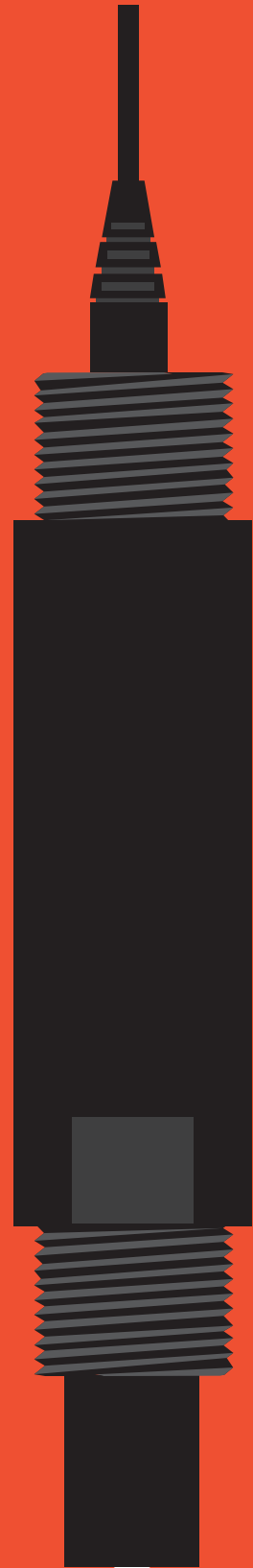

Specifications

Body material	Ryton thermoplastic
Max depth	60m (197 ft)
Cable length	3m (10 feet)
Internal temp. probe	Yes
Temp. probe type	Class A platinum, RTD
Temp. accuracy	+/- (0.15 + (0.002*t))
Tinned leads	Yes
Weight	250 grams
Threading	20mm (3/4") NPT
Sterilization	Chemical only
Food safe	No

This pH probe can be **fully submerged** in fresh or salt water, up to the tinned leads **indefinitely**.

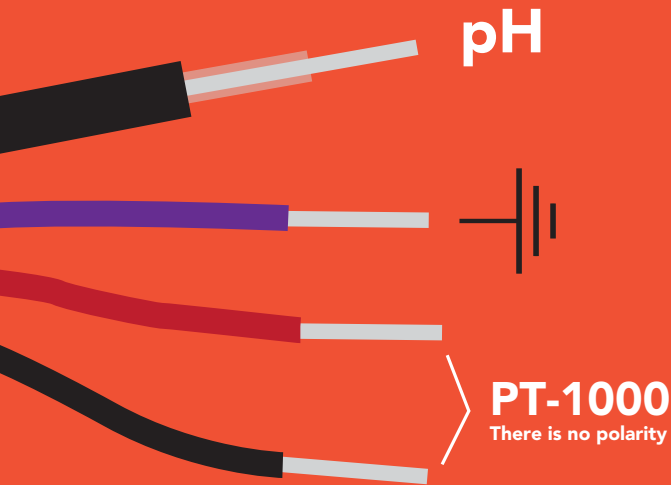

Industrial pH probe cap
~3.8 pH

Sensing area
26.4mm
(1")

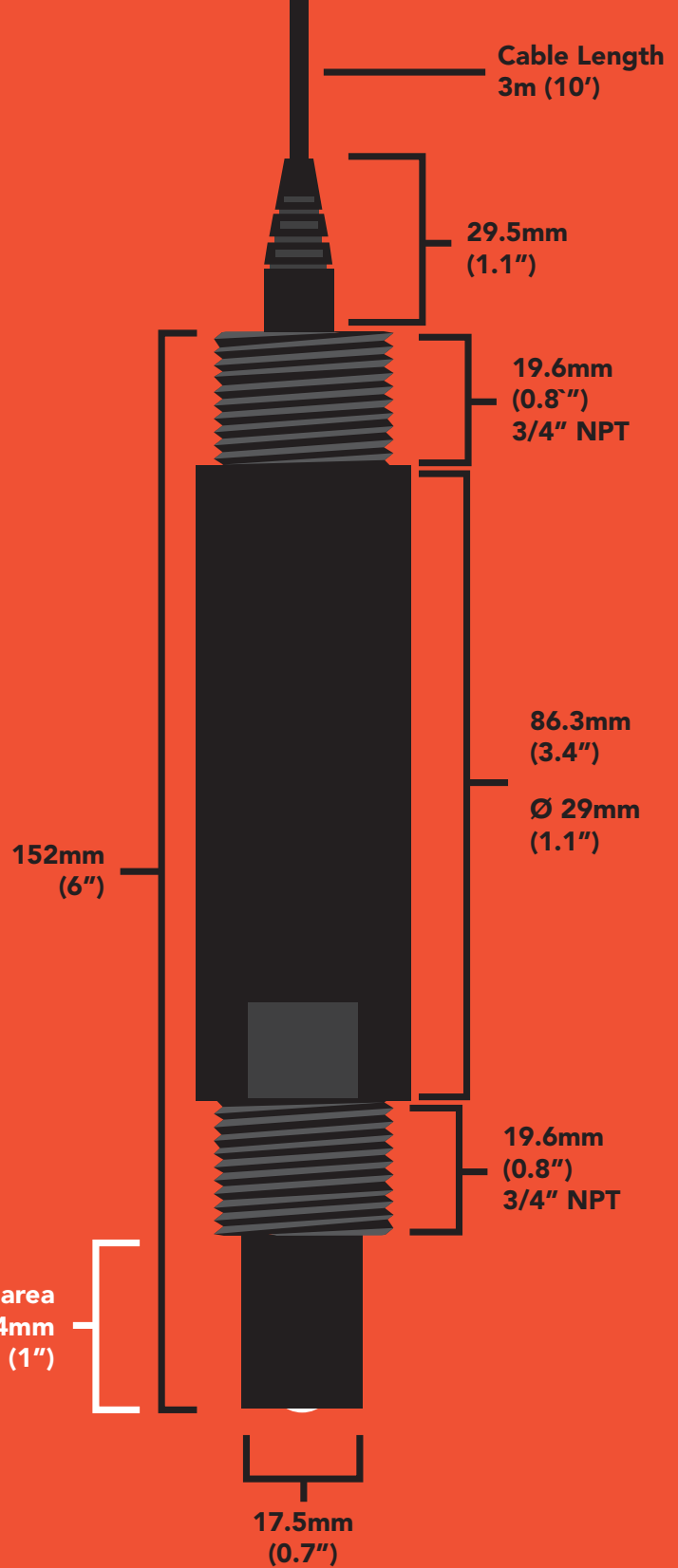

Operating principle

A pH (**potential of Hydrogen**) probe measures the hydrogen ion activity in a liquid. At the tip of a pH probe is a glass membrane. This glass membrane permits hydrogen ions from the liquid being measured to diffuse into the outer layer of the glass, while larger ions remain in the solution. The difference in the concentration of hydrogen ions (outside the probe vs. inside the probe) creates a VERY small current. This current is proportional to the concentration of hydrogen ions in the liquid being measured.

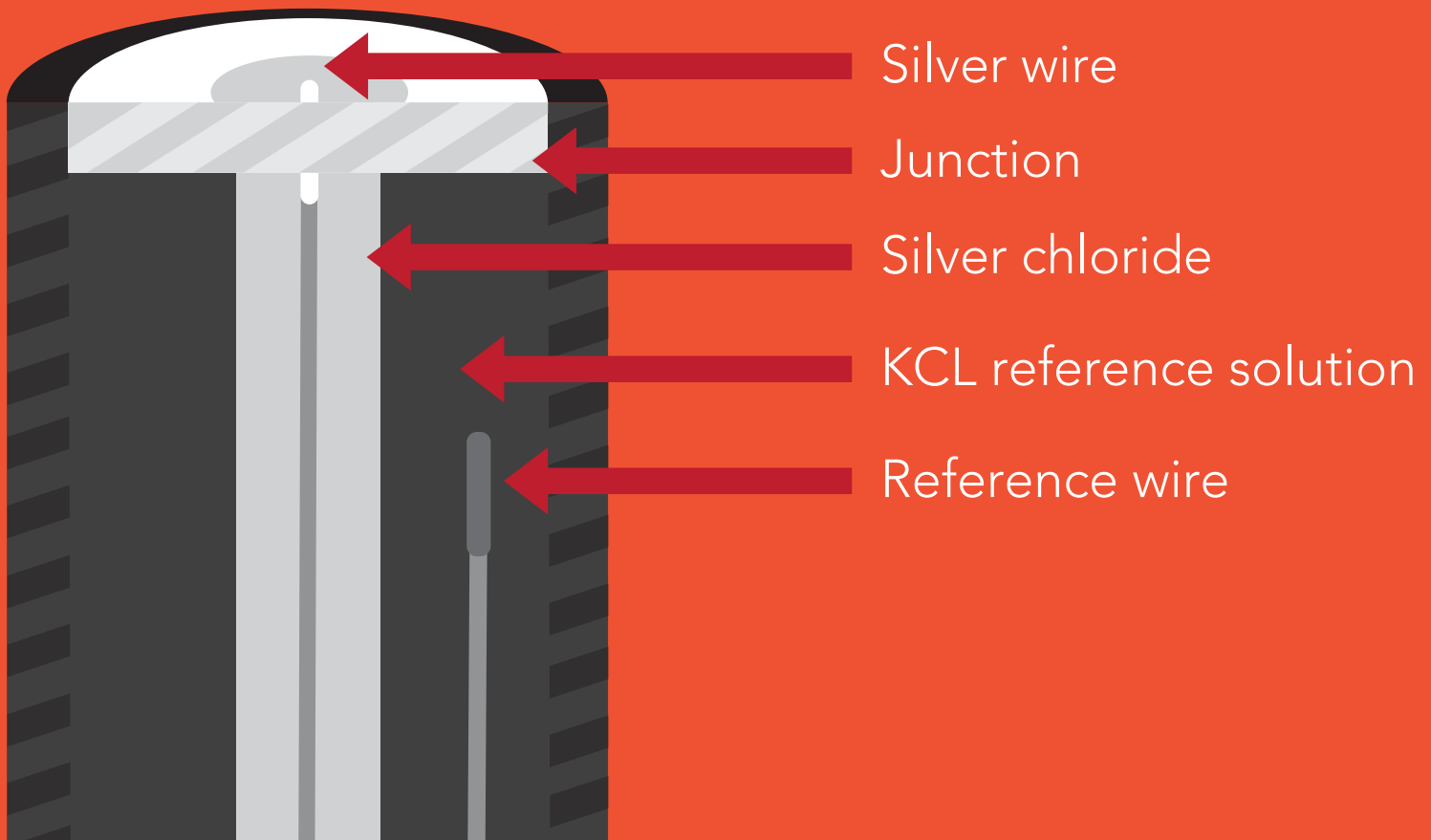
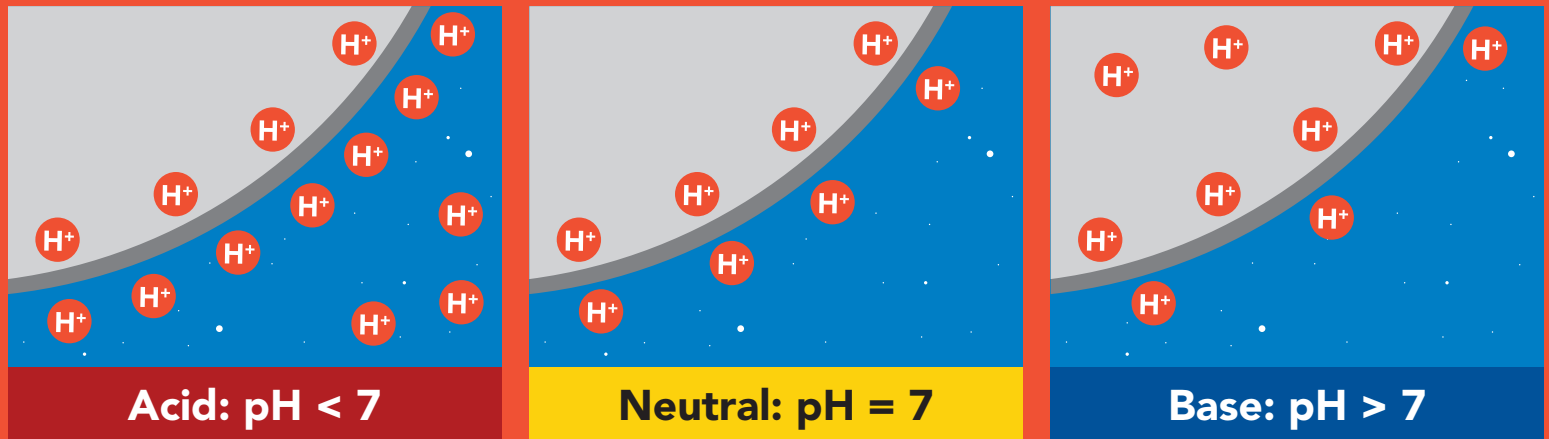

A pH electrode is a passive device that detects a current generated from hydrogen ion activity. This current (*which can be positive or negative*) is very weak and cannot be detected with a multimeter, or an analog to digital converter. This weak electrical signal can easily be disrupted and care should be taken to only use proper connectors and cables.



Result will **always** read zero.

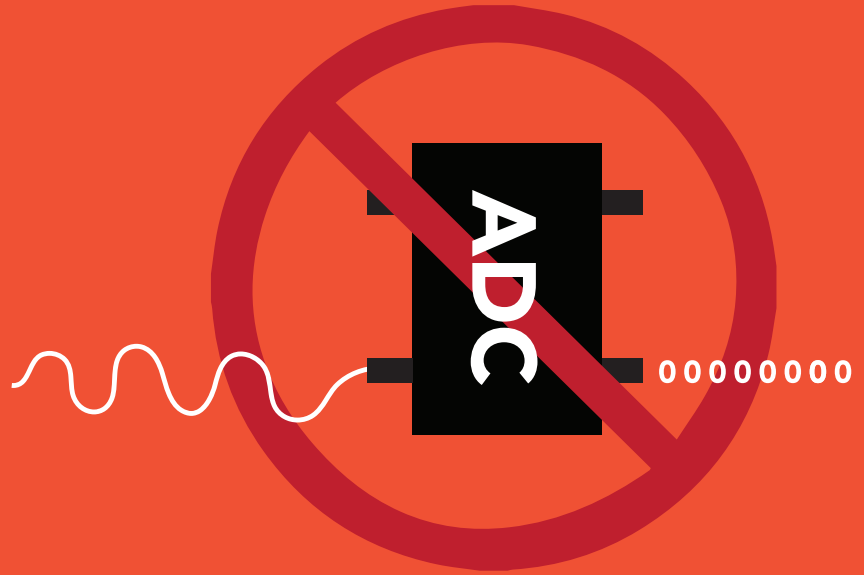

Result will **always** read zero.

The current that is generated from the hydrogen ion activity is the reciprocal of that activity and can be predicted using this equation:

$$E = E^0 + \frac{RT}{F} \ln(\alpha_{H^+}) = E^0 - \frac{2.303RT}{F} pH$$

Where **R** is the ideal gas constant.

T is the temperature in Kelvin.

F is the Faraday constant.

Because a pH probe is a passive device it can pick up voltages that are transmitted through the solution being measured. This will result in incorrect readings and will slowly damage the pH probe over time. In this instance, proper isolation is required.

How to connect the industrial pH probe

The Atlas Scientific™ Industrial pH probe can be connected in several different ways. The following show two examples:

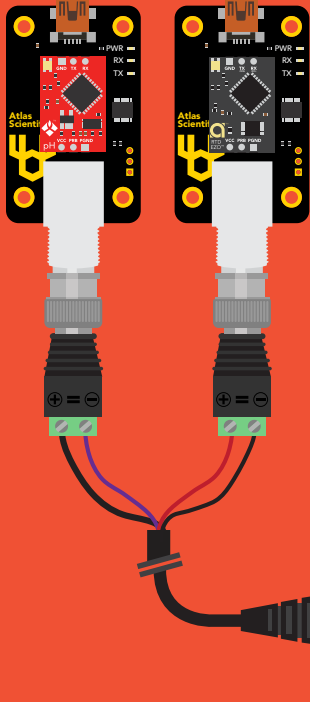

Using two **BNC with Terminal Screws**, you can easily connect the Industrial pH Probe to our **EZO™ pH Circuit** and **EZO™ RTD Circuit** via our **Electrically Isolated USB EZO™ Carrier Board**.

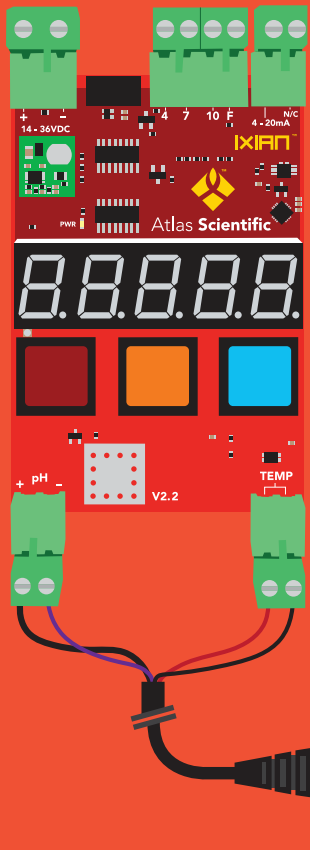

For industrial purposes, the Industrial pH probe connects easily to our **IXIAN™ pH Transmitter**.

pH probes must stay wet and cannot be allowed to dry out, this is why every Industrial pH probe is shipped with a plastic cap containing pH probe storage solution. The cap should remain on the probe until it is used.

Remove the Industrial pH probe cap by turning it clockwise, and pulling the probe out. Make sure to slide the O-ring off the probe.

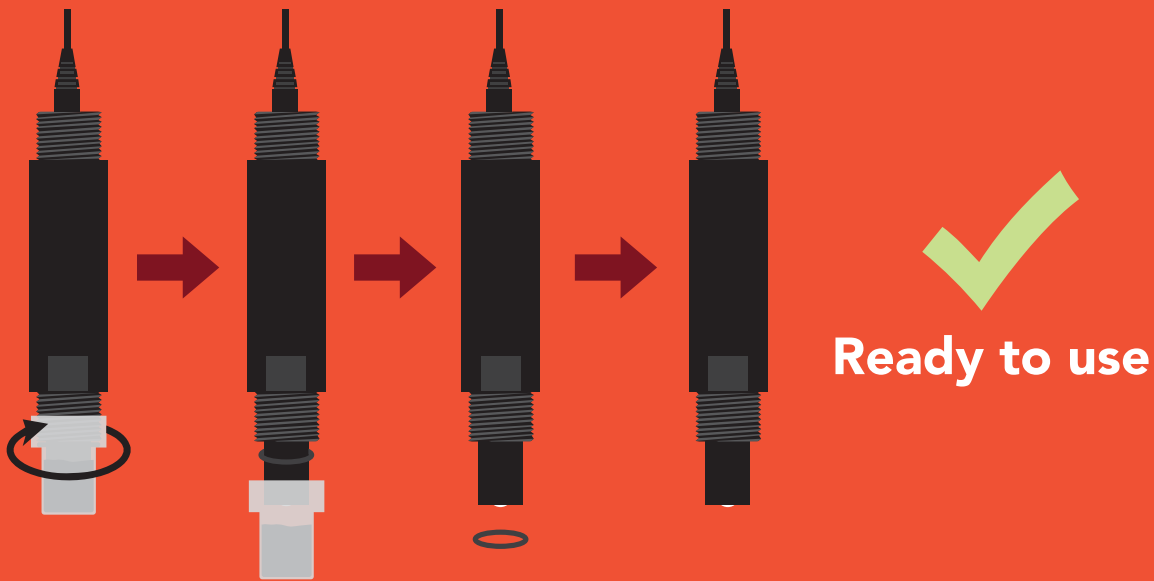

Long term storage

When you are finished using the Industrial pH probe, you can prepare the probe to be used again for a later date. First, make sure the probe cap still has pH probe storage solution within it. If not, just add some from the pH probe storage solution bottle. Replace the O-ring on the probe and tighten the cap back onto the probe by turning it counter-clockwise.

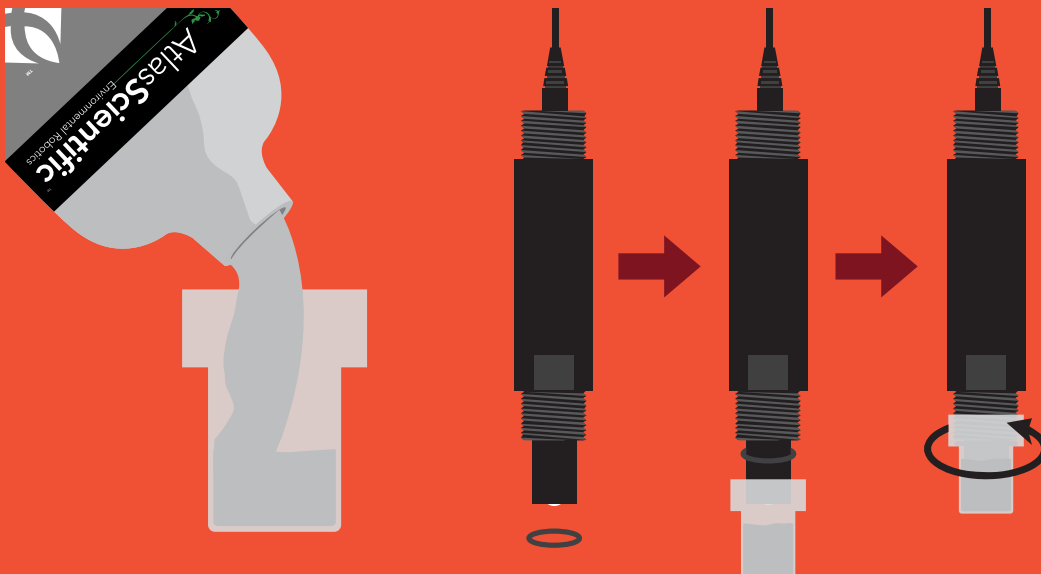

Probe cleaning

Coating of the pH bulb can lead to erroneous readings including shortened span (slope). The type of coating will determine the cleaning technique. Soft coatings can be removed by vigorous stirring or by the use of a squirt bottle. Organic chemical, or hard coatings, should be chemically removed. A light bleach solution or even a 5 – 10% hydrochloric acid (HCl) soak for a few minutes, often removes many coatings. If cleaning does not restore performance, reconditioning may be tried. **Do not use abrasive materials on the pH probe.**

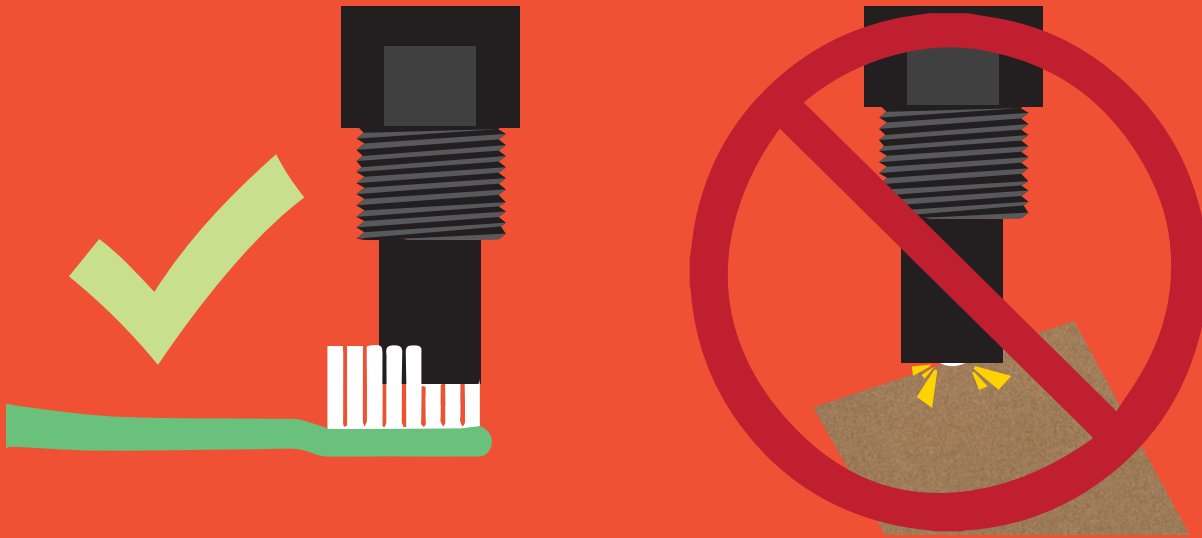

How often do you need to recalibrate a pH probe?

Because every use case is different, there is no set schedule for recalibration.

If you are using your probe in a fish tank, a hydroponic system or any environment that has generally weak levels of acids and bases you will only need to recalibrate your probe once per year for the first two years. After that every ~six months.

If you are using the pH probe in batch chemical manufacturing, industrial process, or in a solution that is known to have strong acids and bases, then calibration should be done monthly or in extreme cases after each batch.

Probe reconditioning

When reconditioning your pH probe is required due to aging, we recommend you use the **Atlas Scientific pH probe reconditioning kit**.

