

# Conductivity Probe K 0.1

## Graphite

Reads	Conductivity
Range	<b>0.07 – 50,000 <math>\mu</math>S/cm</b>
Accuracy	<b>+/- 2%</b>
Response time	<b>90% in 1s</b>
Max pressure	<b>3,447 kPa (500 PSI)</b>
Max depth	<b>343 meters (1,125 ft)</b>
Temperature range °C	<b>1 – 110 °C</b>
Cable length	<b>1 meter</b>
Internal temperature sensor	<b>No</b>
Time before recalibration	<b>~10 years</b>
Life expectancy	<b>~10 years</b>
Maintenance	<b>N/A</b>



# Specifications

K 0.1	0.07 $\mu\text{S}/\text{cm}$ – 50,000 $\mu\text{S}/\text{cm}$
Max depth	343 meters (1,125 ft)
Cable length	1 meter
Weight	51 grams
Measuring Surface	Graphite
Dimensions	12mm x 152mm (0.47" x 6")
BNC connector	Yes
Sterilization	Chemical only
Food safe	Yes

# Typical Applications

- Standard Lab use
- Field use
- Aquarium
- Hydroponics
- Fish keeping
- Mixed aqueous/organic
- Samples containing Heavy metals
- Soil Samples
- Strong reducing agents

This Conductivity probe can be **fully submerged** in fresh or salt water, up to the BNC connector **indefinitely**.

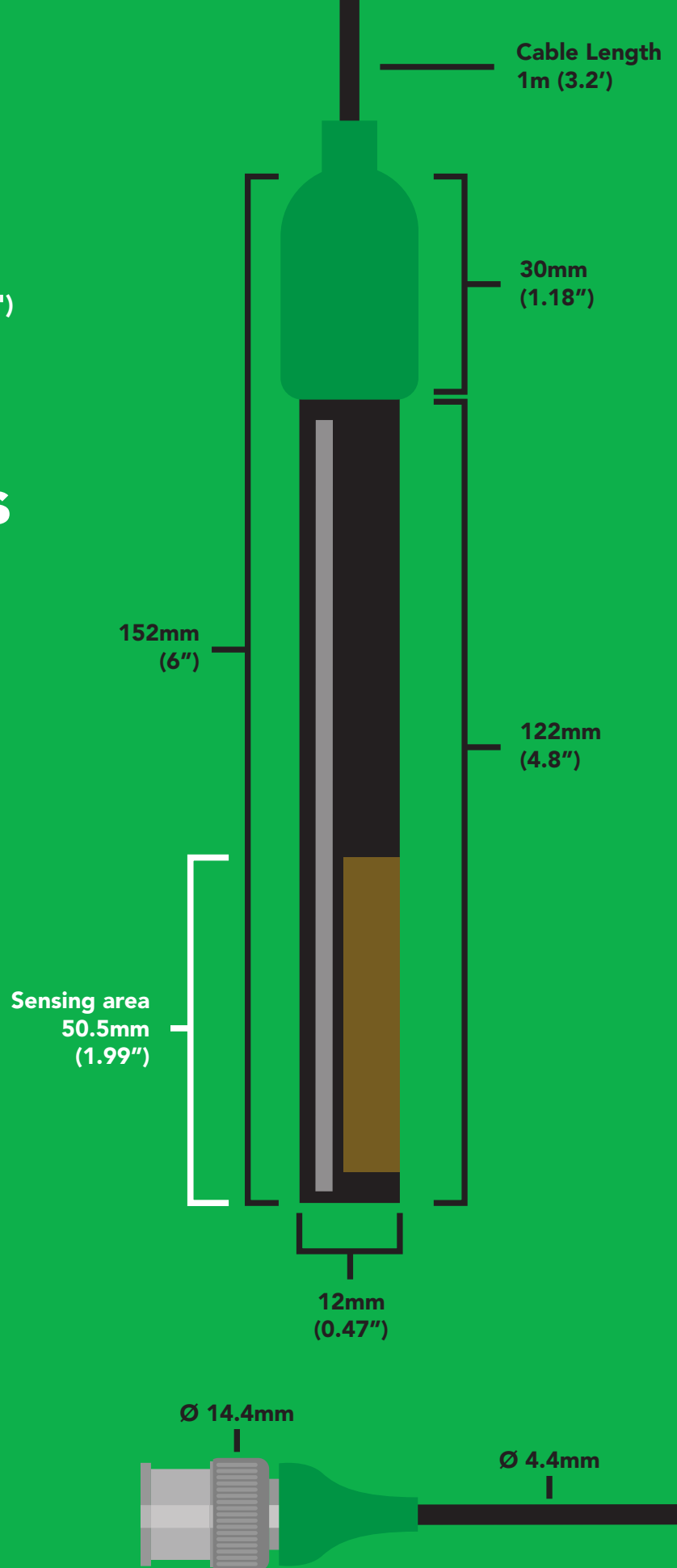

# Operating principle

An E.C. (**electrical conductivity**) probe measures the electrical conductivity in a solution. It is commonly used in hydroponics, aquaculture and freshwater systems to monitor the amount of nutrients, salts or impurities in the water.

Inside the conductivity probe, two electrodes are positioned opposite from each other, an AC voltage is applied to the electrodes causing cations to move to the negatively charged electrode, while the anions move to the positively electrode. The more free electrolyte the liquid contains, the higher the electrical conductivity.

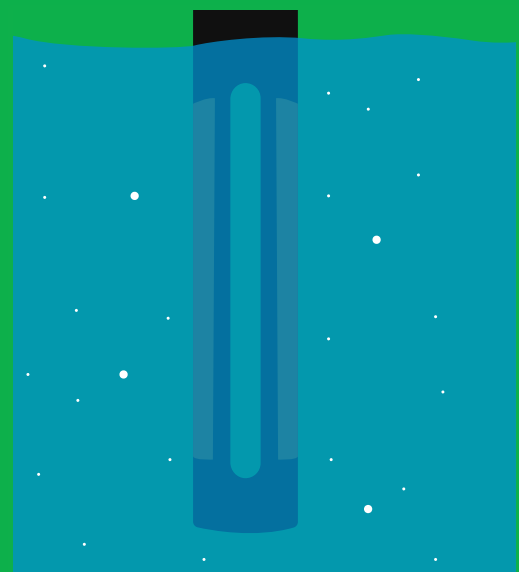
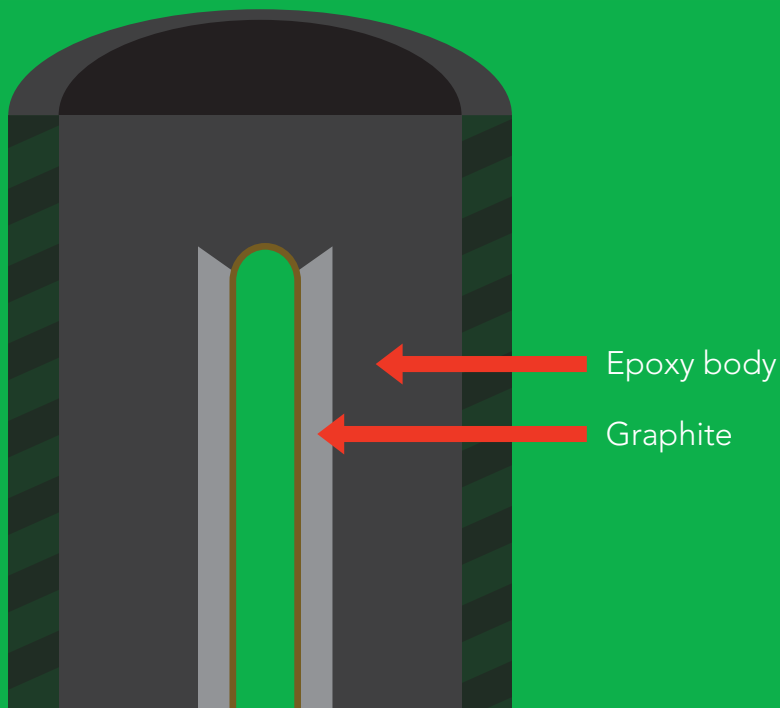
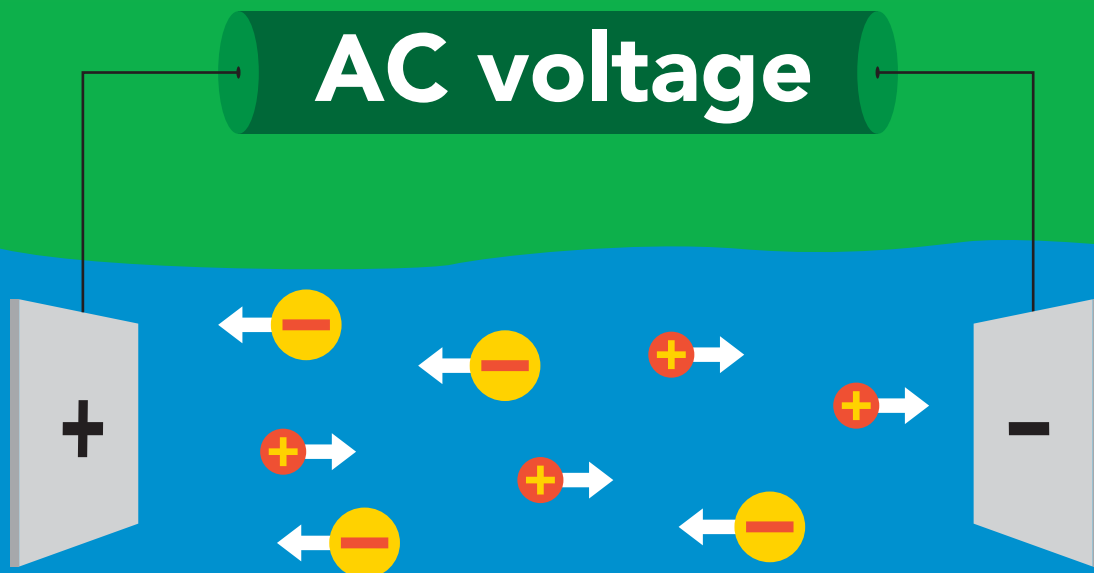

The entire conducting area must be submerged in order to get accurate readings.

A conductivity probe is a very simple device. It is just two conductors with a fixed surface area at a fixed distance from each other. This distance and surface area is known as the conductivity cell. The cells distance and surface area is quantified as the conductivity cells K constant.



Result will *always* read zero.

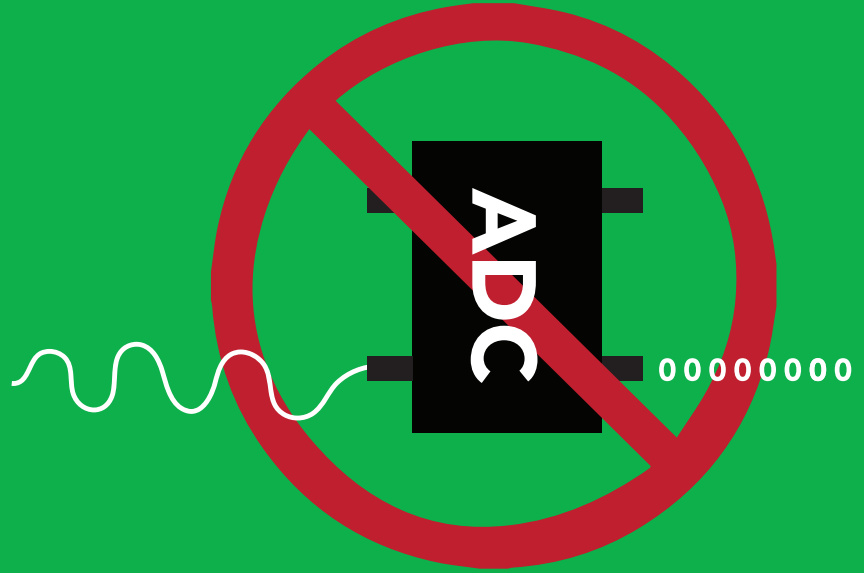

Result will *always* read zero.

## How often do you need to recalibrate a conductivity probe?

Conductivity probes work by measuring the electrical current of the water between two graphite plates. The plates do not go bad, or change, so recalibration is not necessary. After the first calibration your conductivity probe is good to go.

# Extending the probe cable length

You can extend the cable to greater than 100 meters with no loss of signal. Atlas Scientific has tested up to 300 meters without a problem, however you run the risk of turning your E.C. probe into an antennae, picking up noise along the length of your cable.

If you want to extend your cable, we recommend that you use proper isolation, such as the **Basic EZO™ Inline Voltage Isolator**, or **Tentacle Shield**. Be sure to calibrate your probe with the extended cable.

Extending a probe cable can be easily done with our **BNC Extension Cable**. Simply connect the BNC end of the probe to the Extension cable, and you are all set.

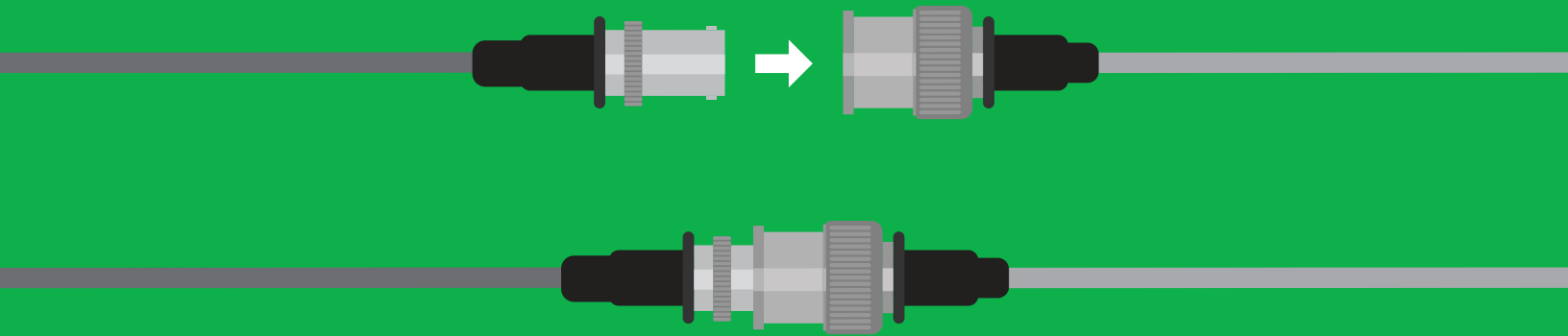

If you need to water proof a BNC connection, we highly recommend using a product like **Coax-Seal** to safely cover and prevent any water damage that may occur.

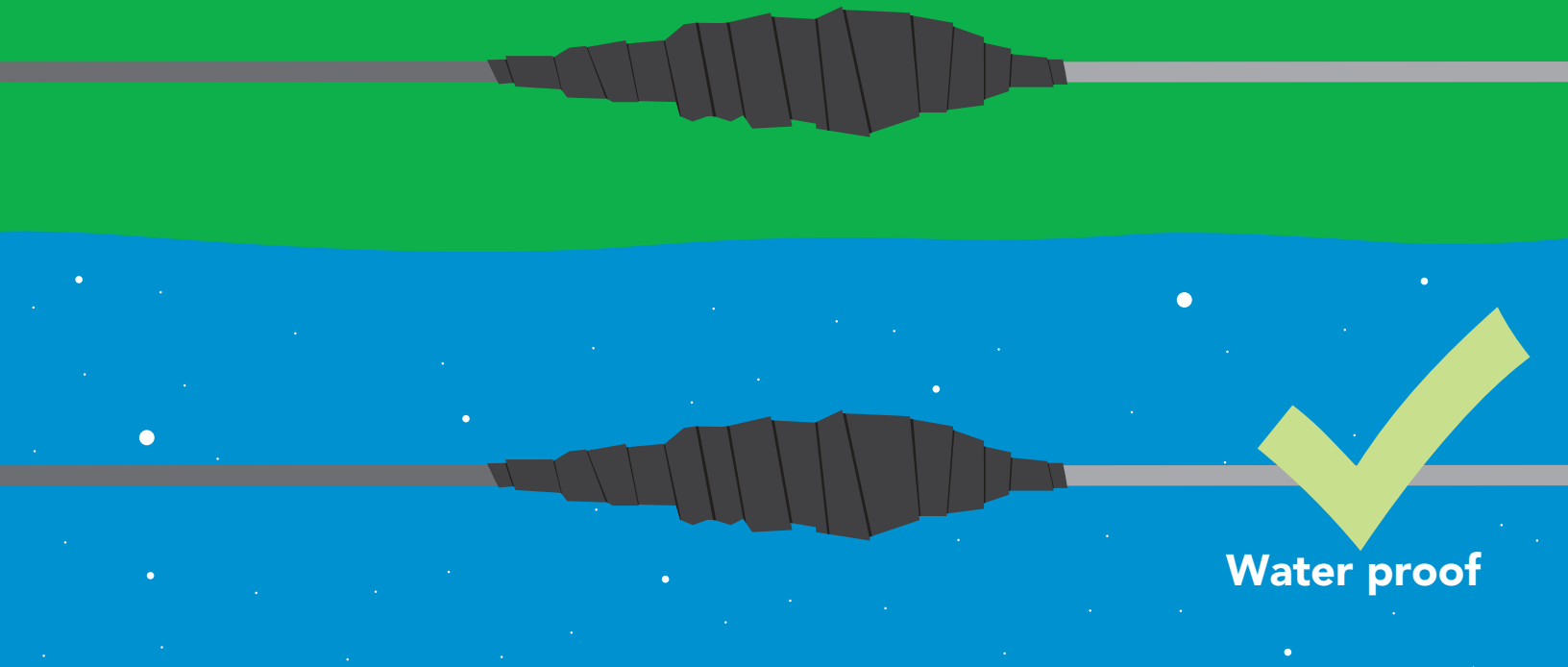

# Helpful operating tips

- 1 Every conductivity probe is shipped with a soft rubber cap that protects it during shipping. Leaving the cap on during use, will cause irregular readings. Gently pull the cap off the probe.

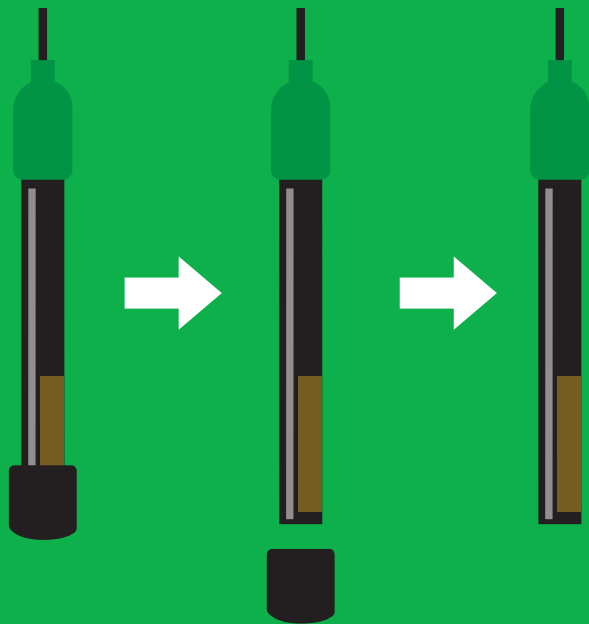

**Ready to use**

- 2 Be sure to watch out for air bubbles, as they can get caught between the two graphite plates and throw off your results. Lightly tap your conductivity probe to knock out any bubbles caught in the probe.

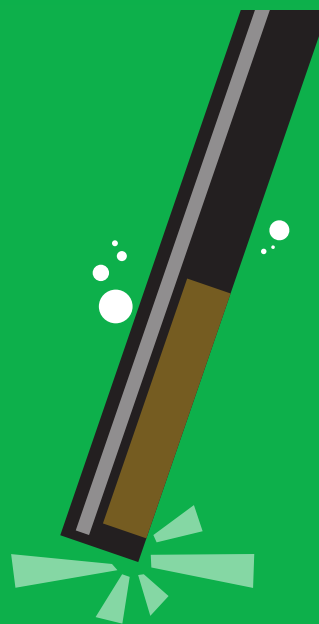
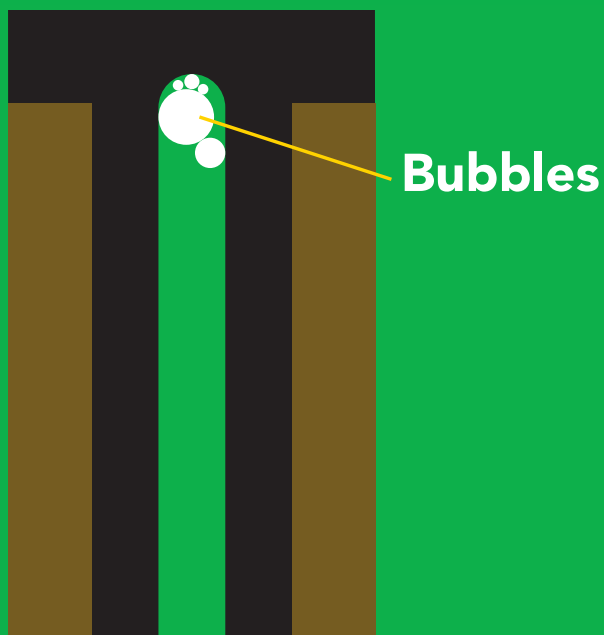

# Probe cleaning

Over time conductivity probes can become dirty and covered in deposits, which can change the basic electrical properties of the probe and cause inaccurate readings.

Soft coatings can be removed by lightly brushing around the conducting area.



Hard coatings should be chemically removed. We highly recommend you use the **Atlas Scientific conductivity probe cleaner**.

